

Owner's Manual



FLOOR OR CEILING UNIT MULTIZONE HEAT PUMP

INVERTER

9 000 to 24 000 BTU/hr

Models:

FCD09KCHVS-I

FCD12KCHVS-I

FCD18KCHVS-I

FCD24KCHVS-I



*Please read this owner's manual carefully
before operating the unit and keep it for future reference.*

TABLE OF CONTENTS

Operation notices	3
Explanation of symbols	3
User notices.....	4
Precautions.....	4
Working temperature range.....	6
Parts name.....	7
Remote control	8
User notice	8
Buttons on remote control.....	9
Icon identification on remote control display	9
Operation of remote control.....	10
Special functions.....	13
Replacing batteries in remote control.....	13
Preparation before installation	14
Outline dimensions of indoor unit	14
Required installation clearance distances diagram.....	14
Selection of installation location.....	15
Requirements for electrical connection	16
Installation	17
Installation of indoor unit	17
Malfunction	23
Malfunction analysis.....	23
Maintenance	24
Cleaning and maintenance	24
Cleaning the surface of the unit.....	24
Cleaning the filter	25
Operation test	26

OPERATION NOTICES

EXPLANATION OF SYMBOLS



DANGER

Indicates a hazardous situation that, if not avoided, will result in serious injury or death.



WARNING

Indicates a hazardous situation that, if not avoided, could result in serious injury or death.



CAUTION

Indicates a hazardous situation that, if not avoided, may result in minor or moderate injury.

NOTICE

Indicates important but not hazard-related information, used to indicate risk of property damage.



Indicates a hazard and it is assigned to the signal words DANGER, WARNING or CAUTION.

USER NOTICES

- The total capacity of the indoor units running at the same time cannot exceed 150% of the outdoor unit capacity. Otherwise, the cooling or heating effect of each indoor unit will be poor.
- To ensure a successful startup, switch the main power on 8 hours before powering on the unit.
- After receiving the "Off" signal, each indoor unit will continue to operate for 20 to 70 seconds to use the remaining cool or warm air in the air exchanger while preparing for the next operation. This is normal.
- When the operating mode of the indoor unit is in conflict with that of the outside unit, a malfunction light will blink for 5 seconds on the indoor unit display or on the controller to warn the user. Then the indoor unit will stop. Change the operating mode of the indoor unit to match that of the outdoor unit or with a compatible mode. COOL mode is compatible with DRY mode and FAN mode is compatible with all operating modes.
- If the supply power fails when the unit is running, the indoor unit will send the "start" signal to the outdoor unit three minutes after power recovery.
- This appliance is not intended for use by people (including children) with reduced physical, sensory or mental capabilities, or lack of experience and knowledge, unless they are under the supervision or instruction concerning use of the appliance by a person responsible for their safety. Children should be supervised to ensure that they do not play with the appliance.
- This product must not be disposed together with the domestic waste. This product has to be disposed at an authorized place for recycling of electrical and electronic appliances.

PRECAUTIONS



WARNING

Operation and Maintenance

- This appliance can be used by people (including children of 8 years old and above) with reduced physical, sensory or mental capabilities, or lack of experience and knowledge, as long as they are under the supervision or instruction concerning use of the appliance by a person responsible for their safety.
- Children shall not play with the appliance.
- Cleaning and user maintenance shall not be made by children.
- Do not connect to multi-purpose socket. Otherwise, it may cause fire hazard.
- Disconnect power supply when cleaning. Otherwise, it may cause electric shock.
- If the power supply wire is damaged, it must be replaced by a qualified person in order to avoid a hazard.
- Do not wash with water to avoid electric shock.
- Do not spray water on indoor unit. It may cause electric shock or malfunction.
- After removing the filter, do not touch fins to avoid injury.
- Do not use fire or hair dryer to dry the filter to avoid deformation or fire hazard.
- Do not operate this unit with wet hands.
- Maintenance must be performed by qualified person. Otherwise, it may cause personal injury or damage.

- Do not repair the appliance by yourself. It may cause electric shock or damage. Please contact a qualified person when you need to repair it.
- Do not extend fingers or objects into air inlet or air outlet. It may cause personal injury or damage.
- Do not block air outlet or air inlet. It may cause malfunction.
- When below phenomenon occurs, please turn off the appliance and disconnect power immediately, and then contact a qualified person for service:
 - There's abnormal sound during operation.
 - Circuit break trips off frequently.
 - The appliance gives off burning smell.
 - Indoor unit is leaking.
- Do not use or place any flammable, combustible or noxious substance next to the unit.
- If the appliance operates in an inappropriate environment or under abnormal conditions, it may cause malfunction, electric shock or fire hazard.
- Keep good ventilation in the room to avoid oxygen deficit.
- Do not step on top panel of outdoor unit, or put on heavy objects. It may cause damage or personal injury.
- When the unit is not to be used for a long time, please cut off the main power supply of the unit.
- Before turning the unit off, make sure it has run for a minimum of 5 minutes; otherwise its service life will be shortened.



WARNING

Wiring

- Installation must be performed by a qualified person. Otherwise, it may cause personal injury or damage.
- Must follow the electric safety regulations when installing the unit.
- According to the local safety regulations, use qualified power supply circuit and circuit breaker.
- Install a circuit breaker of adequate capacity only used for the system; otherwise, it may cause malfunction.
- An all-pole disconnection switch having a contact separation of at least 3 mm in all poles should be connected in fixed wiring.
- The appliance should be properly grounded. Incorrect grounding may cause electric shock.
- Make sure the power supply matches with the requirement of the appliance. Unstable power supply or incorrect wiring may cause malfunction of the unit, electric shock or fire hazard.
- Properly connect the live wire, neutral wire and grounding wire.
- Be sure to cut off the power supply before proceeding any work related to electricity and safety.
- Do not turn the power on before finishing installation.
- If the power supply or signal control wires are damaged, it must be replaced by a qualified person in order to avoid problems.
- During installation, the communication cable and the power cord must not be twisted together but instead separated with an interval of at least 2 cm, otherwise the unit is likely to run abnormally.
- The temperature of refrigerant circuit will be high, please keep the interconnection cable away from the copper tube.

- The appliance shall be installed in accordance with national wiring regulations.
- Installation must be performed in accordance with the requirement of NEC and CEC by a qualified person only.
- The heat pump is a first class electric appliance. It must be properly grounded with specialized grounding device by a qualified person. Please make sure it is always properly grounded, otherwise it may cause electric shock.
- The yellow-green wire in the appliance is the grounding wire, which can't be used for other purposes.
- The grounding resistance should comply with national electric safety regulations.
- All wires of indoor unit and outdoor unit should be connected by a qualified person.
- If the length of power connection wire is insufficient, please contact the dealer for a new one. Do not extend the wire yourself.
- After the electrical installation, take an electric leakage test.



WARNING

Location

- If you need to relocate the appliance to another place, only a qualified person can perform the work. Otherwise, it may cause personal injury or damage.
- Select a location which is out of reach for children and far away from animals or plants. If it is unavoidable, please add a fence around the outdoor unit for safety purpose.
- The location should be able to withstand the weight of the unit. Otherwise, the unit will fall and it may cause injury or death.
- Instructions for installation and use of this product are provided by the manufacturer.

WORKING TEMPERATURE RANGE

	Indoor side state		Outdoor side state	
	Dry bulb temp. °C (°F)	Wet bulb temp. °C (°F)	Dry bulb temp. °C (°F)	Wet bulb temp. °C (°F)
Rated cooling	27 (80)	19 (67)	35 (95)	24 (75)
Max. cooling	27 (80)	19 (67)	46 (115)	24 (75)
Min. cooling	19 (67)	14 (57)	19 (67)	14 (57)
Rated heating	21 (70)	16 (60)	8 (47)	6 (43)
Max. heating	27 (80)	–	24 (75)	18 (65)
Low ambient heating	21 (70)	16 (60)	-15 (5)	-16 (3)

NOTICE

The operating ambient temperature range is:
 Cooling mode: -5 to 48 °C (23 to 118 °F)
 Heating mode: -15 to 27 °C (5 to 81 °F)

PARTS NAME

NOTICE

Actual product may be different from below graphics, please refer to actual product for reference purposes.

Indoor unit

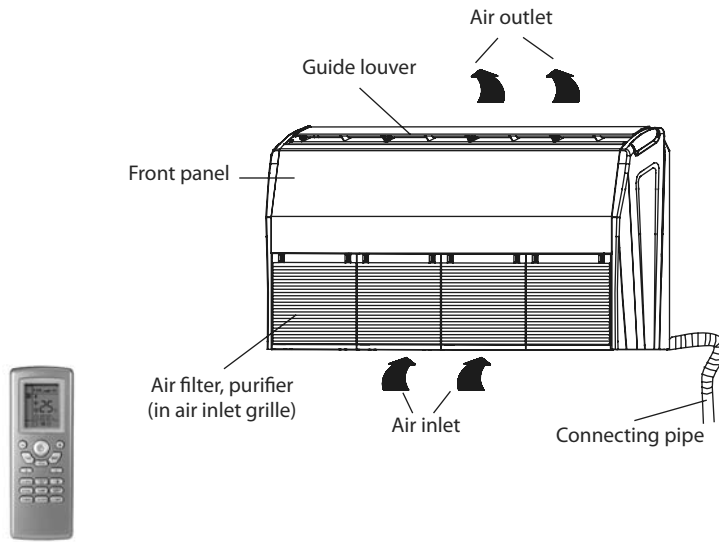

Remote Control

REMOTE CONTROL

USER NOTICES



CAUTION

- The distance between the remote control and receiving window should not be more than 26.25 ft. (8 m) and there should be no obstacle between them
- The remote control should be placed 3.3 ft. (1 m) away from TV or Audio sets.
- The signal can be easily interfered in a room where there is a fluorescent lamp or wireless phone; the remote control should be near the indoor unit when operating.
- Never drop or throw the wireless remote control.
- Never expose the wireless remote control to direct sunlight or to very hot places.
- Never let any liquid flow into the wireless remote control.
- If the remote control does not operate normally, please take out the batteries and reinsert them after 30 seconds. If it is still not working, replace the batteries (see Replacing batteries in remote control section).

NOTES:

- This is a general remote control that could be used for multifunction appliances. If you push a button which is not featured on the model, the unit will continue to work as is.
- During operation, point the remote control at the receiving window on the indoor unit.
- When you are using the remote control for the first time or after replacing batteries, set up the hour with the button CLOCK.

BUTTONS ON REMOTE CONTROL



No.	Bouton	Fonction
1	ON/OFF	Turn on or off the unit
2	-/+	Set temperature and time
3	FAN	Set fan speed
4	MODE	Set operation mode
5	I FEEL	Use of the remote control as ambient sensor
6	HEALTH	Not available on models presented in this manual
7	AIR	Not available on models presented in this manual
8	CLOCK	Set up the clock
9	SWING	Set fan oscillating angle
10	TIMER ON/ TIMER OFF	Set starting and ending time
11	X-FAN	Activation of the AUTO CLEAN function
12	TEMP	Switch temperature displaying type
13	TURBO	Set turbo fan speed
14	SLEEP	Lowering or raising the temperature gradually during the night
15	LIGHT	Lighted display

ICON IDENTIFICATION ON REMOTE CONTROL DISPLAY

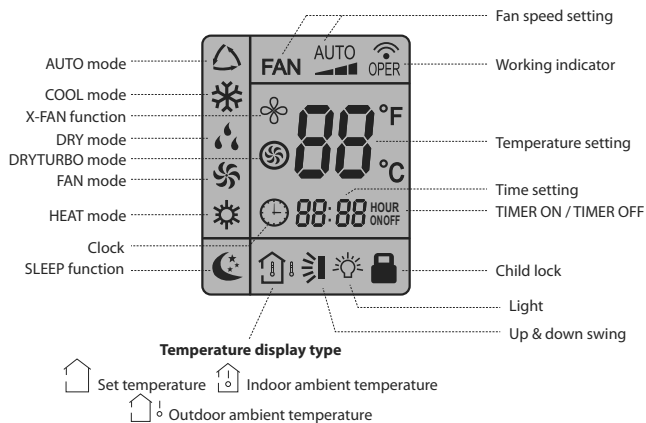

OPERATION OF REMOTE CONTROL

1. ON/OFF button

Pushing this button allows to turn on or off the device. When turning off the unit, the SLEEP function will be canceled but the pre-set time remains.

2. +/- button

Push "+" or "-" button to decrease or increase temperature by one degree at a time.

Temperature range is from 16 °C to 30 °C (61 °F to 86 °F).

Maintain "+" or "-" button pushed for 2 seconds in order to change rapidly temperature. Once settings done, release button and temperature will be modified accordingly (temperature can't be settled in AUTO mode).

While adjusting TIMER ON, TIMER OFF or CLOCK, push "+" or "-" button to set the time. (Please see section CLOCK, TIMER ON, TIMER OFF buttons for more details.)

3. FAN button

Push this button to select the fan speed along this sequence:

Automatic (AUTO), low (▲), medium (▲▲), high (▲▲▲).

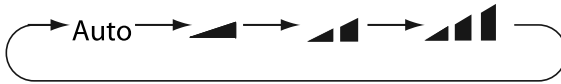

NOTE:

- On AUTO speed, the device will choose ideal speed according to room temperature and set temperature.
- In DRY mode (dehumidification), fan always goes at low speed.

4. MODE button

Push this button in order to select operating mode of your choice:

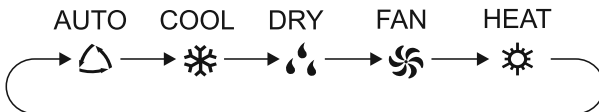

AUTO mode:

When you select automatic mode, the device automatically selects the appropriate function to maintain temperature between 20 °C and 25 °C (68 °F to 77 °F). In this mode, temperature can't be changed or displayed on remote control. When turned on the first time, it works in AUTO mode by default.

COOL mode:

When you select COOL mode, the appliance is cooling the room. Press "+" or "-" to set temperature.

DRY mode:

When you select DRY mode, the appliance is in dehumidifying mode and works at its lowest speed. In this mode, the fan speed can't be changed.

FAN mode:

When you select FAN mode, only the fan is operating. There is no heating, nor cooling in this mode.

HEAT mode:

When you select HEAT mode, device is working on heating mode. Press the "+" or "-" button to adjust temperature.

NOTE:

Cooling only unit can't receive heating mode signal.

5. I FEEL button

Press this button to activate I FEEL function and the icon "⌘" will appear on remote control. Once this function is settled, remote control sends the information about room temperature to the control panel and will adjust automatically. Press again this button to cancel I FEEL function and the icon disappears.

Please put remote control near the user when this function is chosen. Do not put remote control near something at high or low temperature in order to prevent false results.

Make sure to keep the minimum distance recommended between the remote control and the appliance.

6. HEALTH button

This function is not available on models presented in this manual.

7. AIR button

This function is not available on models presented in this manual.

8. CLOCK button

Press this button to set time. Icon "⌚" on remote control will blink. Within the next 5 seconds, press button "+" or "-" to set time. With every push on the button "+" or "-", time increases or decreases by one minute. Hold this either buttons for 2 seconds in order to change time faster. Press again the CLOCK button to confirm the hour and come back to normal display.

NOTE:

- Clock uses 24-hour mode.
- When symbol "⌚" is displayed, time displayed on the remote control is the CLOCK value; otherwise it is the TIMER value.

9. SWING button

Press this button to select oscillating angles for the louvres as per following sequence:

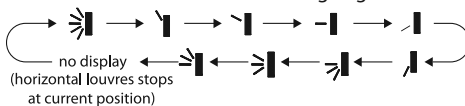

- When selecting "⌘", horizontal louvre will automatically flip upward and downward at a maximum angle.
- When selecting "⌘, >|, <|, >|, <|", the device blows air at fixed position. Horizontal louvre will stop to the chosen position.
- When selecting "⌘, >|, <|", device blows at fixed position. Horizontal louvre will be at fixed angle.
- Hold the SWING button for 2 seconds to define required oscillating angle. When reached, release the button.

NOTE:

"⌘, >|, <|, >|" may not be available. When device receives this signal, it will function as per following position "⌘".

10. TIMER ON button and TIMER OFF button

This timer function allows you to program the unit while determining when it starts and when it ends. Before using this function, make sure your unit is set on the right time.

Setting the starting time of the device:

1. Press TIMER ON button.
2. Press "+" or "-" button in order to set the starting time.
3. Press again TIMER ON to confirm time.

Icon "ON" appears and remote control shows current time.

Setting the ending time of the device:

1. Press the TIMER OFF button.
2. Press the "+" or "-" button in order to set the ending time.
3. Press again TIMER OFF to confirm time.

Icon "OFF" appears and remote control shows current time.

To cancel this function, press the TIMER ON and/or TIMER OFF button and corresponding icons will disappear.

11. X-FAN button

Press this button to activate the AUTO-CLEAN function. After the heat pump turns off, the fan will continue to operate for 2 minutes in order to dry the indoor unit to prevent mold growth.

This function is available only in COOL or DRY mode.

When you press this button, icon "✿" appears on the screen.

12. TEMP button

When pushing this button, you can choose the temperature you wish to see on the indoor unit display: set temperature, indoor room temperature or outdoor temperature.

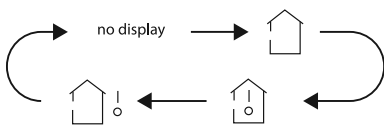

- When "no display" or "no display" is displayed, the set temperature is shown.
- When "house with thermometer" is displayed, indoor room temperature is shown.
- When "house with exclamation mark and thermometer" is displayed, current outdoor temperature is shown.

NOTE:

Current outdoor temperature is not available on all models. In that case, the set temperature is shown.

13. TURBO button

When TURBO function is on, the unit operates at super high speed to achieve quick cooling or heating.

This function is available only in COOL (cooling) or HEAT (heating) mode.

When you press this button, icon "⚡" appears on the screen. Press the button again to cancel TURBO function.

NOTE:

- When TURBO function is activated, fan speed can't be changed.
- This function is not be available on all models.

14. SLEEP button

SLEEP function is available in COOL (cooling), DRY (dehumidifier) and HEAT (heating) modes only. This function permits to gradually increase room temperature in COOL mode and to lower it in HEAT mode. You will then save energy without affecting your sleep. This function is settled over an 8-hour period. After this period of time, the device will work on previous established parameters, as it was set before SLEEP function was activated.

Press this button to activate SLEEP function and the icon "☾" will appear on remote control. Press again this button to cancel SLEEP function and the icon disappears.

15. LIGHT button

Press that button to light the indoor unit display screen. When the light on the display screen is on, icon "☼" appears on the screen.

SPECIAL FUNCTIONS

Child lock function

This function eliminates unwanted temperature adjustments and the use of different modes on the device. Before activating it, make sure to have set the temperature as you like.

Press simultaneously "+" and "-" buttons to activate or deactivate the child lock function. When that function is activated, icon "🔒" is displayed on the remote control.

Temperature display in °C or °F

When device is turned off (OFF), press simultaneously on "-" and MODE buttons to switch from °C or °F.

REPLACING BATTERIES IN REMOTE CONTROL

1. Lightly press the "☺" and slide in the direction the arrow is pointing to remove the back cover of the remote control (as illustrated).
2. Remove the old batteries (as illustrated).
3. Insert two new "AAA" (1.5 V) dry batteries and make sure the position of + and - is correct (as illustrated).
4. Put back the cover (as illustrated).

NOTES:

- When replacing batteries, use only new and identical ones (same brand).
- When you do not use the remote control for a long time, take out the batteries to avoid leakage in the remote control.
- If the remote control does not operate normally, please take out the batteries and reinsert them after 30 seconds. If it is still not working, replace the batteries.
- The batteries must be removed before disposal of the remote control.

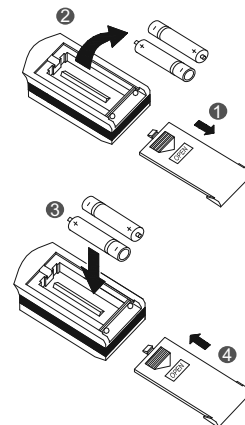

PREPARATION BEFORE INSTALLATION

OUTLINE DIMENSIONS OF INDOOR UNIT

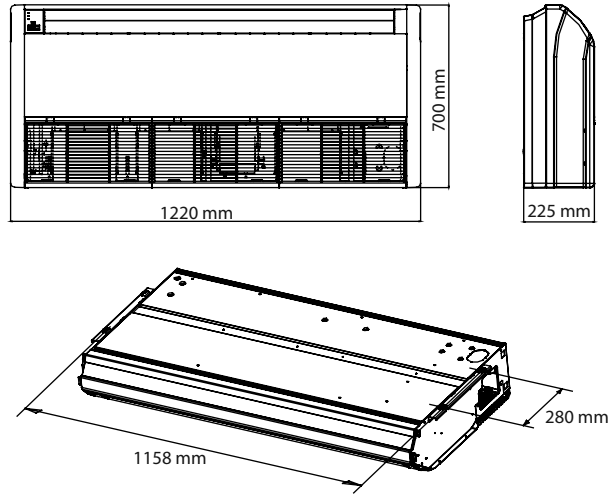

REQUIRED INSTALLATION CLEARANCE DISTANCES DIAGRAM

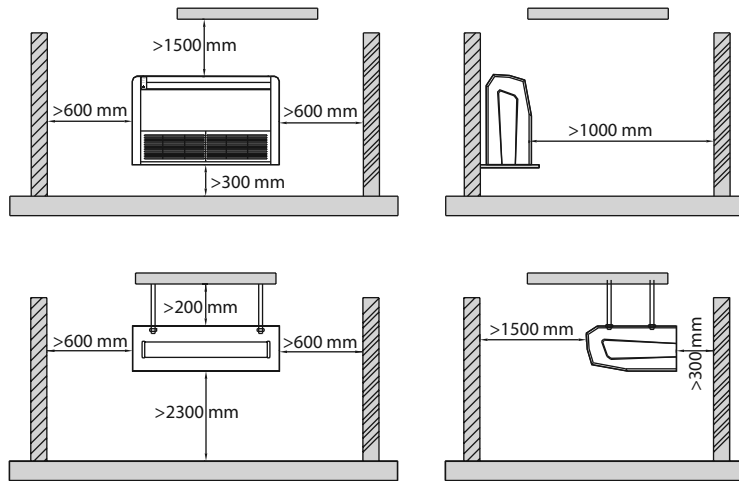

SELECTION OF INSTALLATION LOCATION

Basic requirements

Installing the unit in the following places may cause malfunction. If it is unavoidable, please consult a qualified person:

- A place with strong heat sources, vapors, flammable or explosive gas or volatile objects spread in the air.
- A place with high-frequency devices (such as welding machine, medical equipment).
- A place near coastal regions.
- A place with oil or fumes in the air.
- A place with sulphurous gas.
- Other places with special environment.
- In a laundry room, near a bath, shower or swimming pool.

NOTE:

The power cords and connection lines of the indoor and outdoor units must be at least 3.3 ft. (1 m) away from the TV set or radio to avoid image interference and noise (even if the clearance distance is kept, noise may be produced due to strong electromagnetic wave).

Indoor unit

- There should be no obstruction near air inlet and air outlet.
- Select a location where the drain pipe can be easily connected to the outside.
- Select a location which is convenient to connect the outdoor unit and which is the closest possible to the power supply.
- The location should be able to withstand the weight of indoor unit and will not increase noise and vibration.
- Make sure that the installation follows the requirement of clearance distance diagram.
- Do not install the indoor unit right above an electric appliance.
- The indoor unit should not be exposed to direct sunlight.
- Please try your best to keep the unit away from fluorescent lamps.

REQUIREMENTS FOR ELECTRICAL CONNECTION

Safety precautions

- You must follow the electric safety regulations when installing the unit.
- According to the local safety regulations, use qualified power supply circuit and circuit break.
- Make sure the power supply matches with the requirement of the device. Unstable power supply or incorrect wiring may cause malfunction and damage the unit or fire hazard.
- Properly connect the live wire, neutral wire and grounding wire.
- Cut off the power supply before proceeding any work related to electricity.
- Do not turn on the power before finishing installation.
- The temperature of refrigerant circuit will be high, please keep the interconnection cable away from the copper tube.
- The appliance shall be installed in accordance with national wiring regulations.

Grounding requirements

- The heat pump is a first class electric appliance. It must be properly grounded by a qualified person with specialized grounding device. Please make sure it is always grounded effectively, otherwise it may cause electric shock.
- The yellow-green wire in the appliance is the grounding wire, which cannot be used for other purposes.
- The grounding resistance should comply with national electric safety regulations.
- An all-pole disconnect switch having a contact separation of at least 3mm in all poles should be connected in fixed wiring.

INSTALLATION

INSTALLATION OF INDOOR UNIT

Ceiling and floor mountings both have similar installation procedure as follows:

Step 1: Determine the mounting position

- Using the installation template, determine where the indoor frame will be installed.
- Mark the pattern and remove the installation template.

NOTE:

Make sure that the drainage side is 10 mm lower than the other side in order to drain the condensate water easily.

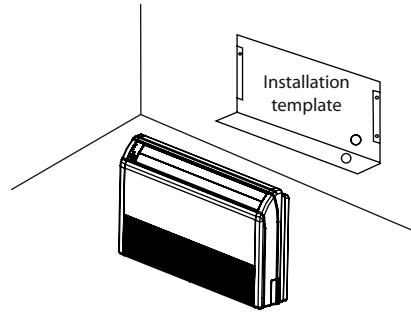

Step 2: Open piping hole

- Choose the position of piping hole according to the direction of outlet pipe.
- Open a piping hole with a diameter of 55 mm or 70 mm depending on selected outlet pipe.
- Allow space around the pipe for an easier indoor unit pipe connection.
- In order to drain efficiently, slant the piping hole on the wall slightly downward to the outdoor side with a gradient of 5° to 10°.

NOTES:

- Pay attention to dust and take relevant safety measures when opening the hole.
- The plastic anchors are not provided and should be bought locally.

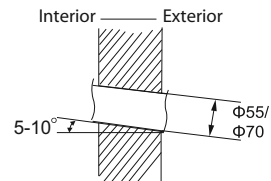

CAUTION

- The suggested shortest pipe length is 8.2 ft. (2.5 m), in order to avoid noise and vibration from the outdoor unit. (Mechanical noise and vibration may occur depending on how the unit is installed and the environment in which it is used.)
- See the installation manual of outdoor unit for information on maximum pipe length.

Step 3: Install drain pipe

- Either the right rear or right side of the unit is suitable for fixing the drain pipe.
- Insert the drain hose completely into the drain socket.
- Add a clamp within the range of gray tape. Tighten until the screw head is less than 4 mm from the hose.
- Add insulating pipe around the indoor drain hose and the clamps in order to prevent condensation.

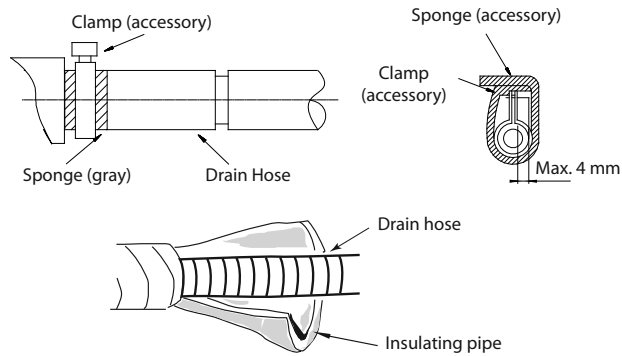

NOTES:

- The diameter of the drain pipe should be larger than or equal to that of the refrigerant pipe. (PVC pipe, outer diameter: 1 in. (25 mm), wall thickness \geq 1/16 in. (1.5 mm)).
- The drain pipe should be as short as possible and have a slope of 1/100 degree minimum to avoid air pockets formation.

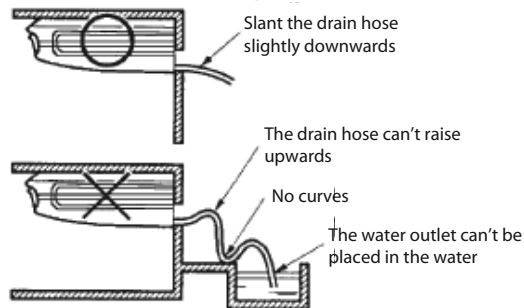

Step 4: Test drainage system

- Pour some water into the drain pan from the air outlet to check if water flow goes through the pipe correctly and observe carefully the joint to see if it leaks or not.

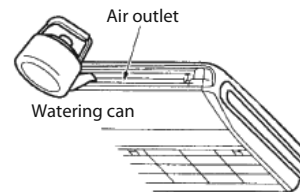

Step 5: Connect the pipe of indoor unit

- To prevent leakage, apply refrigeration oil on both inner and outer surfaces of the nut. Use refrigeration oil for R410A.
- Aim the pipe joint at the corresponding bell mouth.
- Pre-tighten the union nut with hand.
- Place the open-end wrench on the pipe joint and place the torque wrench on the union nut. Tighten the union nut with torque wrench. Adjust the torque force by referring to the following table.

Coat here with refrigeration oil

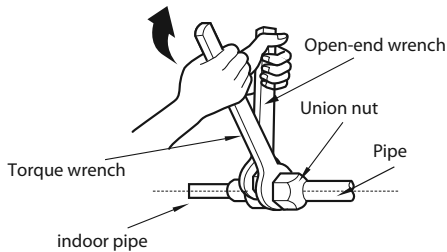
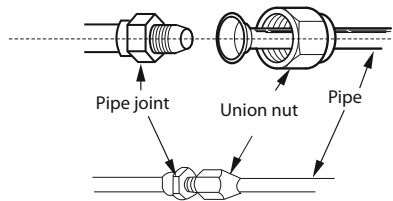
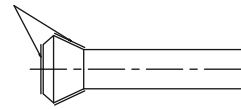

Hex nut diameter	Tightening torque (N·m)
Φ 6	15~20
Φ 9.52	30~40
Φ 12	45~55
Φ 16	60~65
Φ 19	70~75

- Wrap the indoor pipe and joint of connection pipe with insulating pipe, and then wrap it with tape.

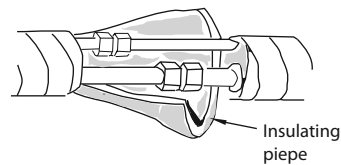

CAUTION

- Protect the open end of the pipe against dust and moisture.
- During the connection of the indoor unit and the refrigerant pipe, never pull any joints of the indoor unit by force; otherwise the capillary pipe or other pipes may crack, which would result in leakage.
- The refrigerant pipe should be supported by brackets. Do not let the unit withstand the weight of it.
- If the pipe diameter of the outdoor unit doesn't match the piping connection size of the indoor unit, use the piping connection size of the indoor unit and add the adaptor supplied with the indoor unit.
- The bending degree of the pipe cannot be too small; otherwise it will crack.
- Use a pipe tube bender to bend the pipe.

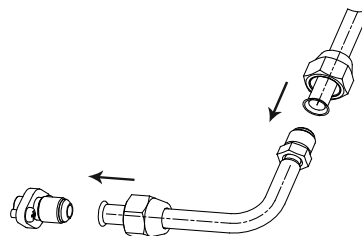
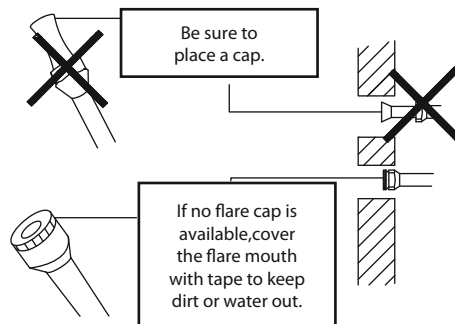

Step 6: Make electrical connections

- Open the front panel.
- Remove the electrical box cover.
- Route the power connection cord from the back of the indoor unit and pull it toward the front through the wiring hole upward.
- Put the 4-core cable through the hole of the chassis and the bottom of the appliance upward, and then connect the power line and the communication line from the outdoor unit to the corresponding terminals N(1), 2, 3, and grounding terminal of the indoor unit. Wiring shall be done properly as per the wiring diagram. (Note: Be sure the wiring terminals A/B/C/D and piping joints A/B/C/D of the indoor unit match with that of the outdoor unit respectively).
- Reinstall the electrical box cover.
- Reinstall the front panel.

NOTES:

- All wires of indoor and outdoor unit should be connected by a qualified person.
- If the length of power connection wire is insufficient, please contact your dealer for a new one. Do not extend the wire by yourself.
- A circuit break must be installed in the line. The air switch should be all-pole parting and the contact parting distance should be more than 3 mm.
- Do not use copper tube at the interconnection part as the temperature of refrigerant circuit is high.

Step 7: Bind up pipes

- Bind up the connection pipe, power cord and drain hose with the band.

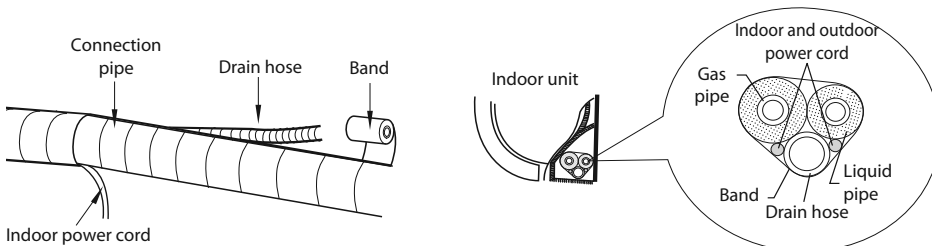

- Reserve a certain length of drain hose and power cord for installation when binding them. When binding to a certain degree, separate the indoor power and then separate the drain hose.
- Bind them evenly.
- The liquid pipe and gas pipe should be bound separately at the end.

NOTES:

- The power cord and control wire cannot be crossed or winded.
- The drain hose should be bound at the bottom.

Step 8: Install the indoor unit

- Press the fixing knob of the air intake grilles. The grilles will open wider.
- Pull the grilles from the indoor unit.
- Loosen the side panel fixing screw and remove the side panel.

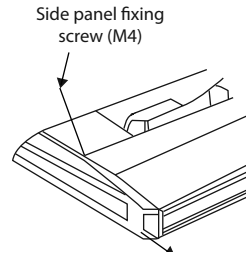

- Loosen two hanger bracket setting bolts (M8) on each side for less than 10 mm.
- Remove two hanger bracket fixing bolts (M6) on the rear side. Detach the hanger bracket by pulling it backward.

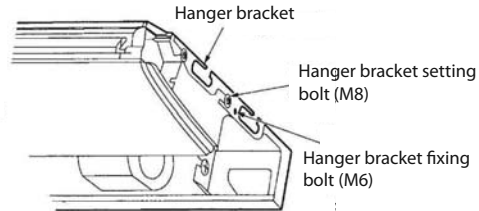

NOTE:

In case of hanging, you can install hanger brackets without removing the brackets from the indoor unit.

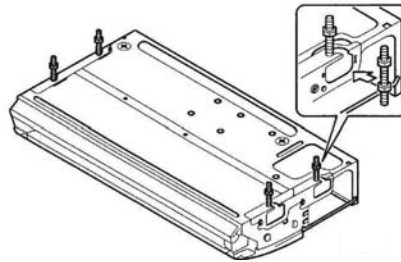

- Set the suspension bolts. (Use W3/8 or M10 size suspension bolts.)

NOTE:

Adjust the distance from the unit to the ceiling beforehand.

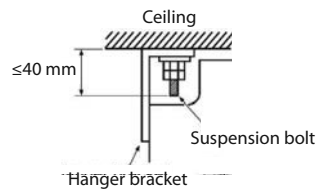

- Fix the hanger brackets to the suspension bolts.



WARNING

- Make sure that extended suspension bolt from the ceiling stays inside the appointed position. Readjust the hanger bracket when it is out of the appointed position.
- Suspension bolt is fixed in the cap of the indoor unit. Never remove the cap.

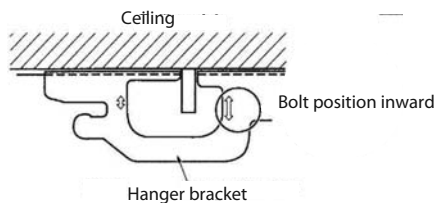

- Lift the unit and slide it forward into place.

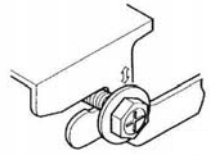

- Tightly screw both hanger bracket setting bolts (M8).
- Tightly screw both hanger bracket fixing bolts (M6) to prevent the displacement of the indoor unit.

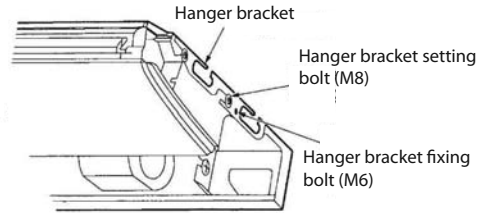

- Adjust the height so that rear side of the drainpipe slightly inclines to improve drainage.

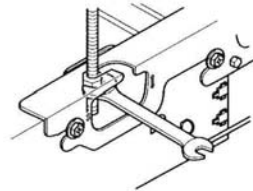

NOTES:

- Adjust the height by rotating the nut with a spanner.
- Insert the spanner into the hanger bracket through the interspace.
- Only the specified accessories and parts for installation work can be used.

- Stuff the gap between pipes and wall hole with sealing gum.

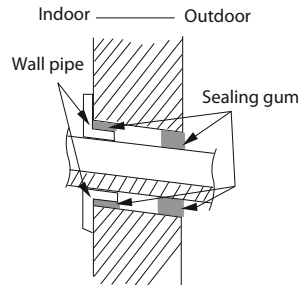

- Fix the wall pipe.
- Check if the indoor unit is installed firmly to the wall/ceiling.
- Reinstall the side panel and return grille.

MALFUNCTION

MALFUNCTION ANALYSIS

Please check below items before asking for servicing. If the malfunction still cannot be eliminated, please contact a qualified person.

Phenomenon	Items to check	Solution
Unit doesn't run at all.	Circuit break trips off?	Ask a qualified person to replace circuit break.
	Is there a power failure?	Wait until power resumes.
	Are the electrical connections properly done?	Ask a qualified person to make proper connections.
	Are the batteries of the remote control low?	Replace batteries with new ones.
	Is the remote control within the signal receiving distance?	Signal receiving distance is 26.25 ft. (8 m).
	Has the unit been turned on immediately after being turned off?	Wait for 3 minutes, and then turn on the unit again.
Unit runs but stops immediately.	Are air inlet or air outlet of indoor or outdoor unit blocked?	Eliminate obstacles.
Abnormal cooling or heating.	Are air inlet or air outlet of indoor or outdoor unit blocked?	Eliminate obstacles.
	Is the set temperature in proper range?	Adjust temperature within proper range.
	Is fan speed on low setting?	Adjust fan setting with the remote control.
	Is the SWING setting ok?	Adjust SWING setting with the remote control.
	Are the doors and windows closed fully?	Close doors and windows.
	Is the unit directly under sunlight?	Hang curtains or blinds in the windows.
	Is there too much heat source or people in the room?	Unit will run normally once the heat sources come back to normal.
	Is the filter dirty?	Clean the filter.
Mist is emitted from the indoor unit air outlet.	Are indoor temperature and humidity level high?	This is because indoor air is cooled rapidly. After a while, indoor temperature and humidity level will decrease and mist will disappear.
Water flowing noise.	Has the unit just been turned on and off?	The noise is the sound of refrigerant flowing inside the unit, which is normal.
Cracking noise.	Has the unit just been turned on and off?	This is the sound of friction caused by expansion and/or contraction of panel or other parts due to temperature changes.
Dust is blown from the unit.	Has the unit been turned on after a long inactivity period?	Dust accumulation in indoor unit is blown out by the fan motor.
Odours are emitted.	Is there an odour source in the room, such as furniture or cigarette?	Eliminate the odour source.
	Is the filter dirty?	Clean the filter.

MAINTENANCE

CLEANING AND MAINTENANCE



WARNING

- Turn off the unit and disconnect the power before cleaning to avoid electric shock.
- Do not wash the unit with water to avoid electric shock.
- Do not use volatile liquid or mineral oils to clean the unit.
- Use suitable instruments for the refrigerant R410A.
- Do not use any other refrigerant than R410A.

Maintenance before seasonal use

- Check if the air inlet/outlet of the indoor unit is clogged.
- Check if circuit breaker and connection are in good condition.
- Check if air filter is clean and well installed.
- To ensure a successful startup, switch the main power on 8 hours before powering on the unit.

Maintenance after seasonal use

- Let the air conditioning unit run for half a day under FAN mode to dry the inside of the unit.
- Disconnect power supply.
- Clean filter and indoor unit panel.
- If you plan not using the unit on a long period of time, shut down the main power supply for energy-conservation. The power indicator on the wired control will go off.

CLEANING THE SURFACE OF THE UNIT

When the surface of indoor unit is dirty, it is recommended to use a softdry cloth or lightly moistened with water to wipe it.

CLEANING THE FILTER

- Never dismantle the air filter except for cleaning; otherwise it may cause some error.
- The filter should be cleaned every three months. If the unit operates in a highly dusty environment, cleaning frequency should be increased (generally once every two weeks).
- If it is necessary to change the filter, purchase a new one at your local dealer.
- Do not use fire or hair dryer to dry the filter to avoid deformation or fire hazard.
- Use a vacuum or water (below 45 °C) to clean the filter and put it in a shady and cool place to dry it.



CAUTION

- Operating the unit without air filters may result in troubles as dust will accumulate inside the indoor unit.

OPERATION TEST

1. Before operation test

- Ensure that the customer is satisfied.
- Inform the customers about the important notes of the appliance.

2. Operation test

- Put through the power, press the ON/OFF button on the remote control to start the unit.
- Press MODE button to select AUTO, COOL, DRY, FAN or HEAT to check whether the operation is normal or not.
- If the ambient temperature is lower than 16 °C, the appliance will not work in COOL (cooling) mode.

3. Operating pressure test

- In COOL or HEAT mode, set the temperature to the maximum set point (30 °C or 86 °F).
- Press the TURBO button to activate the fan TURBO speed.
- Wait until the compressor has reached its full speed (15 to 30 minutes).
- Once full speed is reached, take the operating pressure as well as indoor and outdoor temperature.
- Note your results in the table below and keep it for future reference.

Results of the operating pressure test	
Operating pressure	
Indoor temperature	
Outdoor temperature	

